



HISTORIC PRESERVATION COMMISSION MEETING REPORT

FROM: Community Development Department

BY: Jakob Allen, City Planner

SUBJECT: **COA2602-105 – Design Request for Proposed Single-Family Detached New Construction**

DATE: 03/23/2026

RECOMMENDATION

Historic Preservation Commission to consider the Applicant's design request for a proposed single-family detached new construction at 242 West Marietta Street as submitted and guided by the City of Canton's Historic District Residential Design Guidelines.

DISCUSSION

The Applicant is seeking to build a single-family detached new construction as part of an eight-unit development at the intersection of West Marietta Street, East Marietta Street and Railroad Street. The proposed exterior materials are a combination of board and batten cementitious siding, horizontal cementitious lap siding and Antique Buff brick, accented by a brick water table and / or brick retaining wall. The Applicant is proposing a white color palette with black and grey accents, including an architectural shingle roof and a matching awning to cover a composite wood front porch. All porches are surrounded with railings per life safety standards.

Note that these are revised elevations.

For additional information, please see the attached application.

RELEVANT HISTORIC GUIDELINES AND STANDARDS

The following standards ought to be considered when reviewing this project to ensure it follows the City of Canton's Historic District Residential Design Guidelines.

Building placement is important to ensure new buildings respect the established rhythm of development along a street. Along traditional commercial streets, such as Main Street, the continuous street wall of buildings establishes a visual character and frames the street. Along streets with residential buildings, following the established development pattern ensures new buildings respect the existing character. The following guidelines shall apply to building placement:

Phone: 770.704.1500 | Fax: 770.704.1538 | 110 Academy Street | Canton, Georgia 30114

- 1) Align new construction with the setback and spacing of adjacent buildings. However, avoid using noncontributing, newer buildings as examples to follow when designing new construction projects.
- 2) Window size and placement, as well as storefront openings and height, should be consistent with surrounding historic building facades.
- 3) Locate on-site parking beside or behind buildings. Use side driveways and alleys to access parking areas.
- 4) Locate accessory structures such as garages, carports and sheds in side or rear yards, back from the front wall's plane.

Height and width create scale. Additionally, scale is the proportional relationship of height and width. The two scales that should be addressed in the historic district are the scale of buildings to one another and the scale of architectural features in relation to the building as a whole. When out of scale with their surroundings, or when their individual features do not have proper proportions, buildings appear out of context with their surroundings. The following guidelines shall apply to height, width and scale:

- 1) Design new construction to be similar in height, width and proportions to surrounding historic buildings. For new buildings that are wider than existing buildings, the primary façade should be divided into bays that reflect the predominant width.
- 2) Limit the number of stories to be equal to adjacent structures on either side, or no greater than, two stories greater than the tallest adjacent building. Additional stories are not appropriate if the building appears out of scale with surrounding buildings.
- 3) Building façades should reinforce a human scale. They should not have blank walls (meaning, no openings). Large blank walls or architectural features can make a pedestrian feel small and uncomfortable. Breaking up building facades with architectural details and frequent openings can provide human scale to the face of a building – making pedestrians feel more comfortable next to a building.

Once the form and building placement is established for a new building - including accessory structures - its appearance should be refined so that architectural elements such as materials, size and placement of openings, trim, cornices and other decorative features are compatible with the broader context. The following guidelines shall apply:

- 1) Design building style and features (including roof form) to be compatible with those of surrounding historic buildings. However, designing a building to exactly replicate neighboring historic buildings is discouraged.
- 2) Design the building façades so there are no blank walls.
- 3) Use unpainted brick as the predominant exterior material.
- 4) Use simple color schemes: neutral or earth tone hues for the building surface, and colors that match or complement the dominant neutral building material of the structure for the cornices and framing.
- 5) Refer to Chapter 5 for guidance on appropriate treatments for specific building features.

Outdoor patios and porches can be great amenities for a building. They can expand seating space for restaurants, create a greenspace element or enliven a street with activity. However, they should be designed in context with surrounding buildings and should not conflict with the architecture of the building. The following guidelines shall apply:

- 1) Do not add a porch to front or side façades of commercial buildings where none originally existed.
- 2) Design the porch to be consistent with the architecture of the principal building.
- 3) Storefront, or “façade”, patios may be added if they do not replace historic storefronts. The design should be compatible with original entrances.
- 4) Do not permanently enclose or alter the design of original porch or house foundation walls.
- 5) Situate downspouts along porch supports (or along the edges and corners of buildings) to create minimal visual disruption.
- 6) Do not enclose or fill in front porches or historic side porches that are visible from the street, with the exception of screening (as long as it is installed on the inner plane of the columns and inner side of balustrades).
- 7) Design handicap ramps to incorporate elements of the primary façade, such as continuation of a porch balustrade along the length of the ramp. Locate ramps to the side of rear of the building, where feasible, and respect the architectural style, materials and scale of the principal building.

Doors are often the primary focal point of entrances and serve as a functional and ceremonial element of a storefront. Because of their importance, they require special maintenance and treatment. The following guidelines shall apply to the treatment of doors:

- 1) Retained, restore and maintain original doors.
- 2) If replacement parts are necessary, replace with parts that match original materials and architectural style of the building.
- 3) If replacement of original doors is necessary, replace with custom commercial doors. Residential doors are not appropriate for commercial storefronts and should not be used. Generally, 80% of a commercial door is glass and should match the treatment of display windows.
- 4) If a residential house has been converted to a commercial business, use residential door types. Commercial doors are not appropriate.

Windows are an important element of any building. They add light to the interior of a building, provide ventilation and are a visual link to the outside. They are also an important part of the architectural form and style of buildings. The following guidelines shall apply to the treatment of windows:

- 1) Retain, restore and maintain original windows.
- 2) If replacement parts are necessary, replace with hardware that matches original materials and the architectural style of the building.
- 3) If complete replacement of original windows is necessary, replace with custom replacement windows. Do not replace windows with stock replacement windows, as they often do not fit original openings or require infill casing to make the replacement window fit.
- 4) Uncover and repair windows that are covered-up or in-filled with blocks. If the window is no longer needed, glass should be retained so that it appears from the outside to be in use.
- 5) Windows should have a vertical proportion of height to width.
- 6) Improve thermal efficiency with weather stripping, storm windows, caulking and interior shades.
- 7) Do not cover up or fill in existing windows. The front and sides of buildings should not have blank walls (meaning, no openings).

- 8) Retain and repair (rather than replace) original balconies and fire escapes below windows. If existing landings and railings are too deteriorated, replace with in-kind skeletal assembly to match the historic features.

Roofs serve as functional elements of buildings as well as an decorative features. Functionally, a roof protects the interior of a building from natural elements. This is especially true for managing rain water, as a roof helps direct the water away from a building. Architecturally, a roof provides a decorative accent to the top of a building. To manage both the functional and architectural significance of roofs, the following guidelines shall apply:

- 1) For existing buildings, preserve the original roof shape, structure, pitch and materials.
- 2) Retain and repair original roof materials. If replacement of original materials is necessary, new roof materials should match as closely as possible the texture, color, design and composition of the original materials.
- 3) New roofs should respect the slope and form of adjacent buildings along a street. Commercial buildings typically have shallow shed roofs concealed behind roof cornices and/or parapet walls. Residential buildings typically have pitched roofs, such as a gable or hipped roof.
- 4) Do not install a new roof over an existing roof. Additionally, do not install a new roof that covers or overlaps the parapet wall.

Landscaping varies depending on the character and uses of an area. In commercial areas, such as along Main Street, landscaping on private lots is typically in the form of planters. In residential areas, landscaping is typically a mixture of trees, shrubs, grass and non-vegetative decorative features. The following guidelines shall apply:

- 1) Retain existing trees and plants that define the character of the historic district. Replace diseased or dead plants with native species.
- 2) Repeat the established streetscape design in terms of landscaped borders and screening heights when planting new landscaping.
- 3) Use trees as frequently as possible. They provide shade, help establish edges and mass to a site, and are a source of character for both residential and non-residential areas.
- 4) Use trees and other plants that grow well in southern urban environments.
- 5) Freestanding decorative features such as gazebos, pergolas, fountains or ponds are suitable in rear yards unless there is historic evidence of similar previous existing elements in front or side yards.

A setback is defined as the distance between the front of a building and the property line or right-of-way boundary at the front of the lot. Within the Historic District, setbacks vary depending on the residential or non-residential character along a street. To manage setbacks, the following guidelines shall apply:

- 1) Relate the setback of new construction to adjacent buildings. A new commercial building should follow the setback of adjacent historic commercial buildings. For new residential construction, the setback should range between the smallest setback of adjacent properties and the average of the setbacks of adjacent properties.
- 2) Large government and institutional buildings should be allowed to be setback from the front property line to accommodate a plaza or formal gathering space.
- 3) Large industrial buildings may have a varied setback to accommodate the unique uses and access requirements for operations.

ATTACHMENTS – COA2602-105 Application



Community Development Department

110 Academy Street, Canton, Georgia 30114
770-704-1500

CERTIFICATE OF APPROPRIATENESS APPLICATION

Project # _____ (staff only)

- Application Requirements:** All applications must be complete and include required support materials (listed on the reverse side of this application form). Incomplete applications will not be forwarded to the Canton Historic Preservation (HPC) for review. The applicant must submit the application and all supporting materials as the appropriate building permit option using the online permitting and licensing portal found here: <https://canton.onlama.com/>. For signs, submit the application and all supporting materials as a sign permit using the online permitting and licensing portal found here: <https://canton.onlama.com/>.
- Application Deadline:** Applications and support materials must be submitted fifteen (15) business days prior to the regular HPC meeting. Applications must be submitted to the Community Development Department.
- Application Representation:** The applicant or authorized representative of the applicant must attend the HPC meeting to support the application.
- Building Permit Requirements:** In addition to a COA application, building permits may be required from the Building Department. Building permits will not be issued without proof of a COA.
- Deadline for Project Completion:** After application approval, the COA is valid for 18 months and null and void if construction does not begin within 6 months.
- Local Resources:** [The Canton City Map](#), [The Canton Historic District Design Guidelines](#), and [The Canton Historic District Residential Design Guidelines](#) provides a boundary map of the Canton Historic District, a design review process flowchart and a list of projects that require review and approval (administrative review by Community Development Department staff or review by the Canton HPC). The Guidelines are available at City Hall and on the City of Canton website.

A CERTIFICATE OF APPROPRIATENESS IS REQUIRED FOR ANY MATERIAL CHANGE IN THE APPEARANCE OF PROPERTY (BUILDINGS, STRUCTURES, SITES, OBJECTS, EXTERIOR ENVIRONMENTAL FEATURES) IN A LOCALLY DESIGNATED HISTORIC DISTRICT, AS AUTHORIZED BY THE CITY OF CANTON HISTORIC PRESERVATION ORDINANCE.

Contact Information:

Applicant Name*: PIEDMONT LAND GROUP OF GEORGIA LLC Telephone: 4703713380

Email: vtorres.gamesa@gmail.com

Mailing Address: 5025 Deen Rd, Marietta, Ga. 30066

*NOTE: If the applicant is not the owner, a letter from the owner authorizing the proposed work must be included. Please include the owner's telephone number and mailing address.

Property Information:

Address: 242 W Marietta St. Canton, Ga.

Land Lot(s): LOT 2

District/Section: _____ Map #: _____ Parcel #: _____

Zoning: CBD Present Use: Single-family detached dwelling

Scope of Work: (Check all that apply)

STAFF REVIEW:		HPC REVIEW:	
<input type="checkbox"/> Removal of non-historic detached structure	<input type="checkbox"/> Installation of screen or storm doors	<input type="checkbox"/> Addition	<input type="checkbox"/> Signs
<input type="checkbox"/> Maintenance of / change in paint color	<input type="checkbox"/> Installation of screen or storm windows	<input type="checkbox"/> Alteration	<input type="checkbox"/> Site Features
TYPE OF REVIEW:		X New Construction	<input type="checkbox"/> Demolition
OTHER:		<input type="checkbox"/> Restoration	<input type="checkbox"/> Relocation
		<input type="checkbox"/> Commercial	X Residential
<input type="checkbox"/> Amendment to previous COA, Project #:		<input type="checkbox"/> Other (Description):	



Community Development Department

110 Academy Street, Canton, Georgia 30114
770-704-1500

Application Checklist

A complete application requires support materials. Please check the list below for which materials may be necessary for design review of a particular project.

New Buildings and New Additions

- Letter of Intent
- Site plan
- Architectural elevations
- Landscape plan (vegetation not required)
- Description of materials
- Photographs of proposed site and adjoining properties

Major Restoration, Rehabilitation or Remodeling

- Letter of Intent
- Architectural elevations or sketches
- Description of proposed changes
- Description of materials
- Photographs of existing building
- Documentation of earlier historic appearance (Restoration only)

Minor Exterior Changes

- Letter of Intent
- Description of proposed changes
- Description of materials
- Photographs of existing building

Site Changes – Parking Areas, Drives and Walks

- Letter of Intent
- Site plan or sketch of site
- Description of materials
- Photographs of site

Site Changes – Fences, Walls, and Systems

- Letter of Intent
- Site plan or sketch of site
- Architectural elevations or sketches
- Description of materials
- Photographs of site

Site Changes – Signs

- Letter of Intent
- Approved sign application
- Site plan or sketch of site
- Description of materials or illumination

NOTE: Only complete applications will be placed on the agenda for design review. All plans must be “to scale”. Reduced site plans, surveys, architectural drawings...etc. will not be accepted.

Applications should be submitted to the City of Canton Community Development Department, 110 Academy Street, Canton, Georgia 30114. Please contact 770-704-1500 for more information.

Describe the proposed project (attach additional sheets if necessary). The description should include proposed materials.

Please divide the description whether the proposed scope of work will involve more than one type of project. *Example: 1) Addition of storage and 2) installation of sign.*

Introducing an exclusive collection of eight thoughtfully designed residences nestled within the heart of Canton’s Historic District. This boutique development (Serenity Canton) gated blends timeless architectural character with modern comfort, honoring the rich heritage of the area while offering refined contemporary living. Designed with architectural cohesion and attention to detail.

Each home is carefully crafted to complement the surrounding historic streetscape, with inviting front porches, detailed trim work, and harmonious exterior materials. Spacious open-concept floor plans feature abundant natural light, high ceilings, and seamless indoor-outdoor living.

Gourmet kitchens with premium appliances flow into inviting living areas—ideal for both everyday living and entertaining. Primary suites provide a private retreat with spa-inspired bathrooms and generous walk-in closets.

Each home sits on a well-appointed lot with landscaped yards, covered patios, and carefully designed exterior elevations that create a harmonious streetscape while allowing each residence to feel distinct. Each home will be approximately about 2,500 sqft of heated space.

Located within walking distance of downtown Canton’s shops, restaurants, parks, and cultural attractions, the development provides a rare opportunity to experience small-town charm with modern convenience. Mature trees, pedestrian-friendly sidewalks, and proximity to the Etowah River and Heritage Park enhance the neighborhood’s appeal.

This limited collection of eight homes offers a unique blend of history, craftsmanship, and community — an exceptional opportunity to live in one of Cherokee County’s most desirable and character-rich settings. With only eight homes in the community, residents enjoy a sense of exclusivity and quiet sophistication—an intimate neighborhood atmosphere.

Piedmont Land Group of Georgia 5025
Deen Rd, Marietta, Ga. 30066
470 371 33 80
vtorres.gamesa@gmail.com
February 13th, 2026

City of Canton
Community Development Department 110
Academy St. Canton, Ga. 30114

Subject: Letter of Intent to Request a Building Permit for a 8 houses development.

Dear Community Development Department.

This letter is to express my intent to request a building permit for the construction of an exclusive collection of eight thoughtfully designed residences nestled within the heart of Canton's Historic District. This boutique development (SERENITY Canton) gated blends timeless architectural character with comfort, honoring the rich heritage of the area while offering refined contemporary living, Designed with architectural cohesion and attention to detail.

Each home is carefully crafted to complement the surrounding historic streetscape, with inviting front porches, detailed trim work, and harmonious exterior materials. Spacious open-concept floor plans feature abundant natural light, high ceilings, and seamless indoor-outdoor living. Gourmet kitchens with premium appliances flow into inviting living areas—ideal for both everyday living and entertaining. Primary suites provide a private retreat with spa-inspired bathrooms and generous walk-in closets.

Each home sits on a well-appointed lot with landscaped yards, covered patios, decks and carefully designed exterior elevations that create a harmonious streetscape while allowing each residence to feel distinct. Each home will be approximately about 2,500 sqft of heated space.

Located at 301 W Marietta St, Canton, Ga. 30114, within walking distance of downtown Canton's shops, restaurants, parks, and cultural attractions, the development provides a rare opportunity to experience small-town charm with modern convenience. Mature trees, pedestrian-friendly sidewalks, and proximity to the Etowah River and Heritage Park enhance the neighborhood's appeal.

This limited collection of eight homes offers a unique blend of history, craftsmanship, and community — an exceptional opportunity to live in one of Cherokee County's most desirable and character-rich settings. With only eight homes in the community, residents enjoy a sense of exclusivity and quiet sophistication—an intimate neighborhood atmosphere.

Supporting Documents:

Relating to this proposal, please find attached the following supporting documents:

- Site plan
- Drawings

I look forward to your approval. Thank you,

Sincerely,

Valentin Torres
Piedmont Land Group of Georgia LLC

SITE DEVELOPMENT PLANS FOR: GAMESA PROPERTIES LLC MARIETTA STREET

ZONING: CBD
 PARCEL: 91N16 069 & 91N16 070
 SITE ADDRESS: 301 W MARIETTA ST
 CANTON, GA 30114
 LAND LOT 166
 14th DISTRICT, 2nd SECTION
 CITY OF CANTON
 CHEROKEE COUNTY, GA
 TOTAL AREA: 0.77 ACRES
 DISTURBED AREA: 0.86 ± ACRES

DES PROJECT NO. 21-219.1

SHEET INDEX	
1	COVER SHEET
2	EXISTING CONDITIONS/DEMO PLAN
3	LOT LAYOUT
4	SITE PLAN
5	GRADING & DRAINAGE PLAN
6	STORM PROFILES
7	DRIVEWAY SIGHT LINE PROFILES
8	UTILITY PLAN
9	LANDSCAPE PLAN
10	EROSION CONTROL PHASE 1
11	EROSION CONTROL PHASE 2
12	EROSION CONTROL PHASE 3
13	EROSION CONTROL NOTES & DETAILS 1
14	EROSION CONTROL NOTES & DETAILS 2
15	EROSION CONTROL NOTES & DETAILS 3
16	ROAD CLOSURE PLAN 1
17	ROAD CLOSURE PLAN 2
18	STORMWATER MANAGEMENT DETAILS
19	CONSTRUCTION DETAILS 1
20	CONSTRUCTION DETAILS 2
21	CONSTRUCTION DETAILS 3

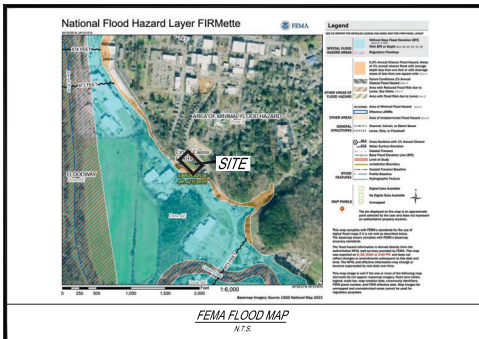

OWNER
 NF GAMESA PROPERTIES LLC
 5025 DEEN ROAD
 MARIETTA, GA 30066

DEVELOPER
 PEPE MEDINA
 837GA-400 SUITE 105
 DAWSONVILLE, GA 30534
 (678) 384-9447

24-HOUR CONTACT
 PEPE MEDINA
 (678) 384-9447
 pepechay@gmail.com

PREPARED BY:

DES DAVIS
 ENGINEERING & SURVEYING
 24 DAWSON VILLAGE
 WAY SOUTH
 DAWSONVILLE, GA 30534
 PHONE: (706) 265-1234
 DAVISENGINEERS.COM

GEORGIA811
 www.Georgia811.com

IF ANY CONFLICTS, DISCREPANCIES, OR ANY OTHER UNSATISFACTORY CONDITIONS ARE DISCOVERED EITHER ON THE CONSTRUCTION DOCUMENTS OR FIELD CONDITIONS, THE CONTRACTOR MUST NOTIFY THE ENGINEER IMMEDIATELY AND SHALL NOT COMMENCE FURTHER OPERATION UNTIL THE CONFLICTS, DISCREPANCIES, OR OTHER UNSATISFACTORY CONDITIONS ARE RESOLVED.

THE INSTALLATION OF EROSION CONTROL MEASURES AND PRACTICES SHALL OCCUR PRIOR TO OR CONCURRENT WITH LAND DISTURBING ACTIVITIES.
 THE LOCATION OF ALL UTILITIES SHOWN ON THESE DRAWINGS ARE APPROXIMATE AND WERE OBTAINED FROM OBSERVATIONS AT THE SITE AND/OR FROM INFORMATION PROVIDED BY THE PROPERTY OR UTILITY OWNERS.
 DAVIS ENGINEERING & SURVEYING, LLC DOES NOT GUARANTEE THAT THE LOCATIONS SHOWN ARE EXACT AND IT SHALL BE THE RESPONSIBILITY OF THE CONTRACTOR TO DETERMINE THE EXACT LOCATIONS OF ALL EXISTING UTILITIES, TO NOTIFY UTILITY OWNERS PRIOR TO CONSTRUCTION, AND TO COORDINATE THE RELOCATION OF ALL THE UTILITIES WHICH CONFLICT WITH THE PROPOSED IMPROVEMENTS SHOWN ON THESE DRAWINGS.

DES DAVIS
 ENGINEERING & SURVEYING
 24 DAWSON VILLAGE
 WAY SOUTH
 DAWSONVILLE, GA 30534
 PHONE: (706) 265-1234
 DAVISENGINEERS.COM



REVISION	DATE	BY	DESCRIPTION
1	12/21/2024	DM	INITIAL SUBMITTAL
2	11/07/2024	DM	REVISED PER CITY OF CANTON AND CDDC
3	08/02/2024	DM	REVISED PER CITY OF CANTON
4	05/29/2025	DM	REVISED PER CITY OF CANTON

COVER
 GAMESA PROPERTIES LLC - MARIETTA STREET
 LAND LOT 166
 14th DISTRICT
 CITY OF CANTON
 CHEROKEE COUNTY, GEORGIA

DESIGN BY:	DM
CHECKED BY:	DM
LAND LOTS:	166
DISTRICT:	14th
SECTION:	2nd
CITY:	CANTON
COUNTY:	CHEROKEE
DATE:	05/29/2025
SHEET NO. 1 of 21	
PROJECT NO. 21-219	

Storm Sewer Tabulation 25 YEAR

Page 1

Station	Line To Line	Length (ft)	Catchment Area (sq ft)		Tc (min)	Inlet Elev (ft)	Outlet Elev (ft)	Slope (%)	Dn (in)	Up (in)	Dn (ft)	Up (ft)	Line ID
			Inlet	Outlet									
7	6	4,000	0.00	0.00	0.00	5.0	0.0	872.00	872.00	0.0	0.0	0.0	C3-C4
6	5	30,000	0.00	0.00	0.00	0.0	0.0	871.75	871.75	0.0	0.0	0.0	C2-C3
5	4	20,000	0.00	0.00	0.00	0.0	0.0	871.50	871.50	0.0	0.0	0.0	C1-C2
4	2	50,700	0.00	0.00	0.00	0.0	0.0	869.75	869.75	0.0	0.0	0.0	A3-A4
3	2	30,000	0.00	0.00	0.00	0.0	0.0	869.50	869.50	0.0	0.0	0.0	A3-A3.1
2	1	143,800	0.00	0.00	0.00	0.0	0.0	869.25	869.25	0.0	0.0	0.0	A2-A3
1	End	68,520	0.00	0.00	0.00	0.0	0.0	869.00	869.00	0.0	0.0	0.0	A1-A2

Project File: 21-219 W MARETHA ST - 11-24-20
Number of Lines: 7
Run Date: 11/10/2024

Notes: Intensity = 0.12 (10min time @ 0.70" h^{1.48} ft^{0.77}). Return period = 1.05. c = 0.014 s = 4.0 ft³ s = 1.0

Storm Sewer Tabulation 100 YEAR

Page 1

Station	Line To Line	Length (ft)	Catchment Area (sq ft)		Tc (min)	Inlet Elev (ft)	Outlet Elev (ft)	Slope (%)	Dn (in)	Up (in)	Dn (ft)	Up (ft)	Line ID
			Inlet	Outlet									
7	6	4,000	0.00	0.00	0.00	5.0	0.0	872.00	872.00	0.0	0.0	0.0	C3-C4
6	5	30,000	0.00	0.00	0.00	0.0	0.0	871.75	871.75	0.0	0.0	0.0	C2-C3
5	4	20,000	0.00	0.00	0.00	0.0	0.0	871.50	871.50	0.0	0.0	0.0	C1-C2
4	2	50,700	0.00	0.00	0.00	0.0	0.0	869.75	869.75	0.0	0.0	0.0	A3-A4
3	2	30,000	0.00	0.00	0.00	0.0	0.0	869.50	869.50	0.0	0.0	0.0	A3-A3.1
2	1	143,800	0.00	0.00	0.00	0.0	0.0	869.25	869.25	0.0	0.0	0.0	A2-A3
1	End	68,520	0.00	0.00	0.00	0.0	0.0	869.00	869.00	0.0	0.0	0.0	A1-A2

Project File: 21-219 W MARETHA ST - 11-24-20
Number of Lines: 7
Run Date: 11/10/2024

Notes: Intensity = 0.12 (10min time @ 0.30" h^{1.48} ft^{0.77}). Return period = 100. c = 0.014 s = 4.0 ft³ s = 1.0

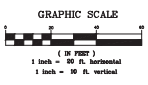
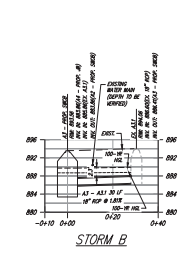
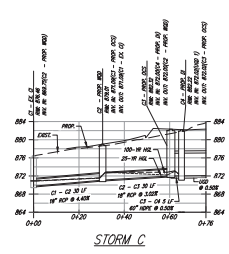
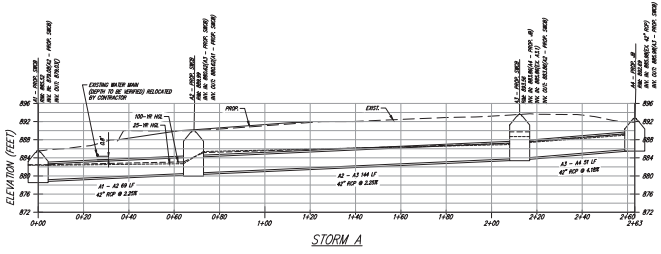

DES
DAVIS
ENGINEERS & ARCHITECTS
24 DAWSON VILLAGE
W. W. SCOTT II
DANVILLE, GA 30534
PHONE: 706.586.1334
DAVISENGINEERS.COM

05/29/2025

REVISION	DATE	DESCRIPTION
1	11/10/2024	INITIAL DESIGN
2	11/10/2024	REVISED FOR CITY OF CANTON AND OWNER
3	05/02/2025	REVISED FOR CITY OF CANTON
4	05/02/2025	REVISED FOR CITY OF CANTON

STORM & PROFILES
 GAMESA PROPERTIES LLC - MARETHA STREET
 LAND LOT 196
 14th CITY OF CANTON
 CHEROKEE COUNTY, GEORGIA

DESIGNER:	JAW
CHECKED BY:	CH
LAND LOTS:	196
DISTRICT:	140
SECTION:	2nd
CITY:	CANTON
COUNTY:	CHEROKEE
STATE:	GA

SHEET NO.
6 of 21

PROJECT NO.
21-219

CONTRACTOR: DES DAVIS ENGINEERS & ARCHITECTS, INC. 24 DAWSON VILLAGE, WICKLIFFE, GEORGIA 30189-4404
 PROJECT: DRIVEWAY SIGHT LINE PROFILES FOR WEST MARIETTA CONNECTION, CHESTERFIELD, GEORGIA
 DATE: 05/29/2025

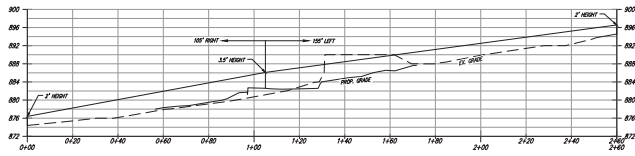

SIGHT DISTANCE LEFT & RIGHT (EAST MARIETTA STREET)

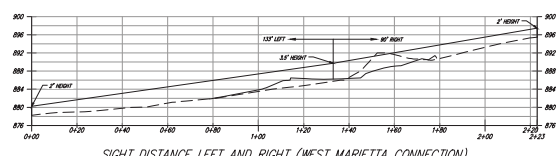

SIGHT DISTANCE LEFT AND RIGHT (WEST MARIETTA CONNECTION)

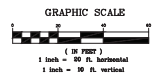
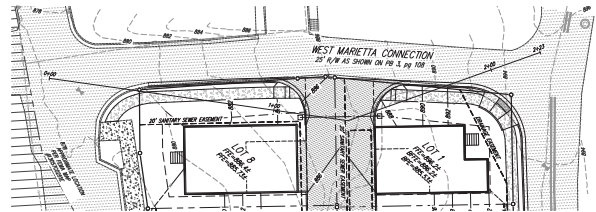
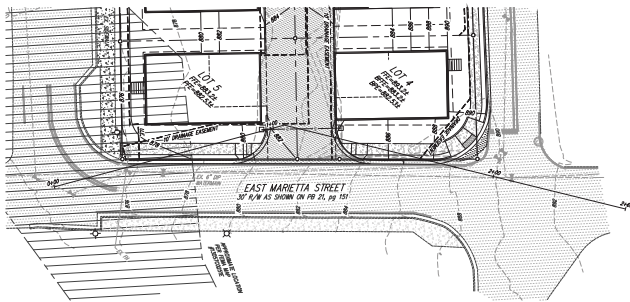

DES DAVIS
ENGINEERS & ARCHITECTS
24 DAWSON VILLAGE
WICKLIFFE
DANVILLE, GA 30534
PHONE: 706.386.1314
DAVISENGINEERS.COM

05/29/2025

REVISION	DATE	DESCRIPTION
1	07/24/2024	INITIAL SUBMITTAL
2	11/07/2024	REVISED PER CITY OF CANTON AND OWNER
3	02/02/2025	REVISED PER CITY OF CANTON
4	05/29/2025	REVISED PER CITY OF CANTON

DRIVEWAY SIGHT LINE PROFILES
 GAMESA PROPERTIES LLC - MARIETTA STREET
 LAND LOT 106
 14th CITY OF CANTON
 CHESTERFIELD, GEORGIA

DRAWN BY:	300
CHECKED BY:	DN
LAND LOT:	106
DISTRICT:	14th
SECTION:	2nd
CITY:	CANTON
COUNTY:	CHESTERFIELD
DATE:	05/29/2025

SHEET NO.	7 of 21
PROJECT NO.	21-219

Ds3 DISTURBED AREA STABILIZATION (WITH PERMANENT VEGETATION)

NOTE: OWN STRAW OR GRASS MAY BE SPREAD AS A BEDDING MATERIAL FOR ALL PERMANENTLY GRASSED AREAS AT A MINIMUM DEPTH OF 4" TO 6". FINE NETS MAY BE SUBSTITUTED AT A MINIMUM DEPTH OF 3" TO 5".

NOTE: AGROCHEMICAL LIME IS REQUIRED FOR ALL GRADED AREAS AT THE RATE OF ONE TO TWO TONS PER ACRE UNLESS SOIL TESTS DETERMINE OTHERWISE.

SPECIES	RATE PER 1000 SQ YD	RATE PER ACRE	PLANTING DATES	FIRST SEEDING DATE	PERIODS TO SECOND SEEDING	IN TOP DRESSING
WEeping LOwGRASS AND VIRGATA OR SERICEA LESPEDEZA	0.1 lb. 4 lb.	3/15-6/15	2/1-6/15	2/1-4/15	FIRST 6 12 12 1500 50	-
SERICEA LESPEDEZA SEEDING MAT WITH EXPRESSED WEeping LOwGRASS	1.0 lb. 3 bags	10/1-3/1	10/1-1/1	10/15-2/1	FIRST 8 12 12 1500 50	-
MULLED COMMON BERMUDAGRASS AND SERICEA LESPEDEZA	0.2 lb. 10 lb. 1.4 lb. 60 lb.	3/1-7/1 3/15-6/15	1/15-7/1 1/1-6/15	2/15-6/15	FIRST 6 12 12 1500 50 SECOND 0 15 10 1000 -	-
UNMULLED COMMON BERMUDAGRASS AND VIRGATA OR SERICEA LESPEDEZA	0.2 lb. 10 lb. 1.4 lb. 40 lb.	10/1-3/1 3/15-6/15	11/1-2/1 1/1-6/15	2/15-6/1 10/15-2/1	FIRST 6 12 12 1500 50 SECOND 0 15 10 1000 -	-
TALL FESCUGRASS AND VIRGATA OR SERICEA LESPEDEZA	1.1 lb. 50 lb. 1.4 lb. 40 lb.	4/1-1/1 3/15-6/15	1/15-11/1 1/1-6/15	2/15-6/1 10/15-2/1	FIRST 6 12 12 1500 50 SECOND 0 15 10 1000 -	0-50
MULLED COMMON BERMUDAGRASS	0.2 lb. 10 lb.	3/1-7/1	2/15-7/1	2/15-6/1	FIRST 6 12 12 1500 50-100 SECOND 10 10 10 800 50-100	-

1. REDUCE SEEDING RATES BY SIZE WHEN DRILLED.
2. FERTILIZER/N TOP-DRESSING RATES INDICATED ARE IN LBS/ACRE.

Ds1 DISTURBED AREA STABILIZATION (WITH MULCHING ONLY) MATERIALS AND RATES:

MATERIAL	RATE
STRAW OR HAY	3-4" DEEP
WOOD WASTE, CHIPS, SAW DUST OR BARK	2-3" DEEP/FACED 8-8" DIA. FACE
MATTING OR NETTING	ACCORDING TO MANUFACTURER'S RECOMMENDATIONS
POLYETHYLENE FILM COVER AREA	COMPLETELY

Ds2 DISTURBED AREA STABILIZATION (WITH TEMPORARY SEEDINGS) SEEDING RATES FOR TEMPORARY SEEDINGS:

SPECIES	RATE PER 1000 SQ YD	RATE PER ACRE	PLANTING DATES	FIRST SEEDING DATE	PERIODS TO SECOND SEEDING	IN TOP DRESSING
RYE (IN MATS)	0.5 POUNDS	2 lb.	3/15-12/1	4/15-1/1	8/15-3/1	-
ANNUAL RyEGRASS (IN MATS)	0.5 POUNDS	40 lb.	8/1-5/1	3/1-4/15	8/15-4/1	-
ANNUAL LESPEDEZA (IN MATS)	0.2 POUNDS	40 lb.	2/1-5/1	2/15-5/1	1/15-3/15	-
WEeping LOwGRASS (IN MATS)	0.1 POUNDS	4 lb.	3/15-6/15	3/15-6/15	2/15-6/15	-
SUDAGRASS (IN MATS)	1.4 POUNDS	60 lb.	4/1-9/1	4/1-9/1	3/1-8/1	-
BROWNTOP MILLET (IN MATS)	0.5 POUNDS	40 lb.	4/1-7/1	4/1-7/15	4/1-7/15	-
WHEAT (IN MATS)	0.1 POUNDS	3 lb.	9/1-1/1	9/1-1/1	8/15-2/1	-

1. TEMPORARY COVER CROPS ARE VERY COMPETITIVE AND WILL CHOKEN OUT PERENNIALS IF SEEDS TOO HEAVILY.
2. REDUCE SEEDING RATES BY SIZE WHEN DRILLED.

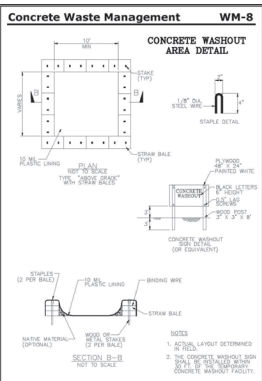
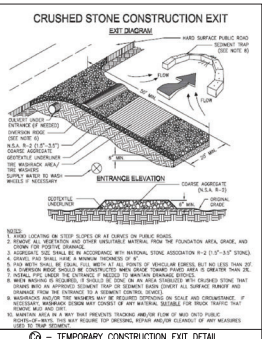
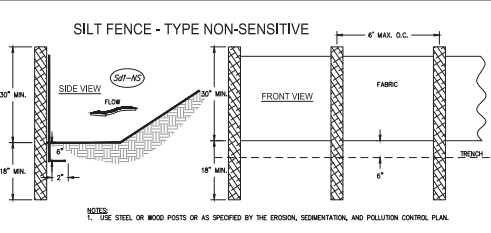

NOTES:
1. VERIFY THAT ALL EROSION CONTROL MEASURES AND TEMPORARY CONSTRUCTION EXIT DETAIL REQUIRE TOP SURFACE, EXPOSED AND UNEXPOSED AREAS BEING RELEASED TO THE ROAD SURFACE.
2. VERIFY THAT ALL EROSION CONTROL MEASURES AND TEMPORARY CONSTRUCTION EXIT DETAIL REQUIRE TOP SURFACE, EXPOSED AND UNEXPOSED AREAS BEING RELEASED TO THE ROAD SURFACE.
3. VERIFY THAT ALL EROSION CONTROL MEASURES AND TEMPORARY CONSTRUCTION EXIT DETAIL REQUIRE TOP SURFACE, EXPOSED AND UNEXPOSED AREAS BEING RELEASED TO THE ROAD SURFACE.

DESIGNER: JASON K. DAVIS, P.E.
CHECKED BY: JASON K. DAVIS, P.E.
DATE: 05/29/2025

DES DAVIS
ENGINEERS & ARCHITECTS
24 DAWSON VILLAGE
WICK BOUTTE
DARIENVILLE, LA 70544
PHONE: (504) 284-1334
DAVISENGINEERS.COM

REVISION

NO.	DATE	DESCRIPTION
1	05/29/2025	ISSUE FOR PERMIT
2	05/29/2025	ISSUE FOR PERMIT
3	05/29/2025	ISSUE FOR PERMIT
4	05/29/2025	ISSUE FOR PERMIT

EROSION CONTROL NOTES & DETAILS
GAMES PROPERTY LLC - MARETHA STREET
LAND LOT 106
14th CITY OF CANTON
CHEROKEE COUNTY, GEORGIA

PROJECT NO: 21-219
SHEET NO: 14 of 21

FABRIC AND SUPPORTING FRAME FOR INLET PROTECTION

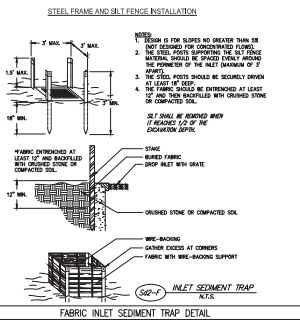

CURB INLET FILTER 'PIGS IN BLANKET'

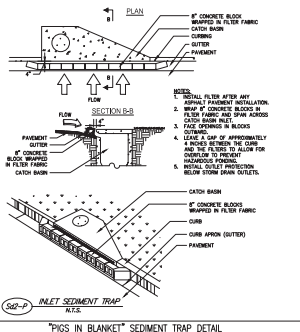

Dust Control on Disturbed Areas



DEFINITION
Controlling surface air movement of dust and soil particles from a site.

PURPOSE
To prevent surface air movement of dust from exposed soil surfaces.

CONDITIONS
This practice is applicable to areas subject to surface and air movement of dust where on- and off-site damage may occur without treatment.

METHOD AND MATERIALS
A. Temporary Methods
Mulches. See standard D-1 - Disturbed Area Stabilization (With Mulching Only). Synthetic mats may be used instead of mulch to track traffic. Refer to specification Tac - Trackifiers. Restraints should be used according to manufacturer's recommendations.

B. Permanent Methods
Disturbed Area Stabilization (With Permanent Seeding).
Spray-on Adhesives. These are used on mineral soils (not effective or much soils). Keep traffic off these areas. Refer to specification Tac - Trackifiers.

measure that should be used before wind erosion starts. Begin blowing on windward side of site. Checktopes plows spaced about 12 inches apart, spring-toothed harrows, and similar plows are effective in controlling wind erosion.

Irrigation. This is generally done as an emergency treatment. Site is sprinkled with water until the surface is wet. Repeat as needed.

Barriers. Solid board fences, snowfences, hinged fences, cone walls, bales of hay and similar material can be used to control air currents and soil blowing. Barriers placed at right angles to prevailing currents at intervals of about 10 times their height are effective in controlling wind erosion.

Calcium Chloride. Apply at rate that will keep surface moist. May need reapplication.

Permanent Methods
Permanent Vegetation. See specification D-3 Disturbed Area Stabilization (With Permanent Vegetation). Existing trees and large shrubs may afford visibility protection if left in place.

Topping. This entails covering the surface with less erosive soil. See specification 7a - Topping.

Stems. Cover surface with crushed stone or coarse gravel. See specification Co-Construction Road Stabilization.

TIrrigation. This practice is designed to roughen and strip clods to the surface. It is an emergency measure.

BLANKET AND MATTING CROSS-SECTIONS

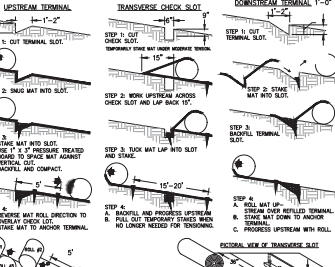

NEED:
1. STAY AT DOWNSTREAM TERMINAL AND PROTECT UPSTREAM.
2. FILL SLOPE WITH SLOPE STABILIZATION MATERIAL.
3. SLOPE STABILIZATION MATERIAL SHOULD BE PLACED AT DOWNSTREAM TERMINAL.
4. SLOPE STABILIZATION MATERIAL SHOULD BE PLACED AT DOWNSTREAM TERMINAL.
5. SLOPE STABILIZATION MATERIAL SHOULD BE PLACED AT DOWNSTREAM TERMINAL.

EROSION CONTROL AND POLLUTION CONTROL PLAN CHECKLIST
PROJECT NAME: _____ ADDRESS: _____
LOCAL PERMIT NUMBER: _____ STATE PERMIT NUMBER: _____
DATE: _____

NO.	DESCRIPTION	DATE	STATUS
1	1. Erosion Control Plan, including a table of contents, shall be submitted for review and approval by the local authority.		
2	2. Erosion Control Plan, including a table of contents, shall be submitted for review and approval by the state authority.		
3	3. Erosion Control Plan, including a table of contents, shall be submitted for review and approval by the local authority.		
4	4. Erosion Control Plan, including a table of contents, shall be submitted for review and approval by the state authority.		
5	5. Erosion Control Plan, including a table of contents, shall be submitted for review and approval by the local authority.		
6	6. Erosion Control Plan, including a table of contents, shall be submitted for review and approval by the state authority.		
7	7. Erosion Control Plan, including a table of contents, shall be submitted for review and approval by the local authority.		
8	8. Erosion Control Plan, including a table of contents, shall be submitted for review and approval by the state authority.		
9	9. Erosion Control Plan, including a table of contents, shall be submitted for review and approval by the local authority.		
10	10. Erosion Control Plan, including a table of contents, shall be submitted for review and approval by the state authority.		
11	11. Erosion Control Plan, including a table of contents, shall be submitted for review and approval by the local authority.		
12	12. Erosion Control Plan, including a table of contents, shall be submitted for review and approval by the state authority.		
13	13. Erosion Control Plan, including a table of contents, shall be submitted for review and approval by the local authority.		
14	14. Erosion Control Plan, including a table of contents, shall be submitted for review and approval by the state authority.		
15	15. Erosion Control Plan, including a table of contents, shall be submitted for review and approval by the local authority.		
16	16. Erosion Control Plan, including a table of contents, shall be submitted for review and approval by the state authority.		
17	17. Erosion Control Plan, including a table of contents, shall be submitted for review and approval by the local authority.		
18	18. Erosion Control Plan, including a table of contents, shall be submitted for review and approval by the state authority.		
19	19. Erosion Control Plan, including a table of contents, shall be submitted for review and approval by the local authority.		
20	20. Erosion Control Plan, including a table of contents, shall be submitted for review and approval by the state authority.		
21	21. Erosion Control Plan, including a table of contents, shall be submitted for review and approval by the local authority.		
22	22. Erosion Control Plan, including a table of contents, shall be submitted for review and approval by the state authority.		
23	23. Erosion Control Plan, including a table of contents, shall be submitted for review and approval by the local authority.		
24	24. Erosion Control Plan, including a table of contents, shall be submitted for review and approval by the state authority.		
25	25. Erosion Control Plan, including a table of contents, shall be submitted for review and approval by the local authority.		
26	26. Erosion Control Plan, including a table of contents, shall be submitted for review and approval by the state authority.		
27	27. Erosion Control Plan, including a table of contents, shall be submitted for review and approval by the local authority.		
28	28. Erosion Control Plan, including a table of contents, shall be submitted for review and approval by the state authority.		
29	29. Erosion Control Plan, including a table of contents, shall be submitted for review and approval by the local authority.		
30	30. Erosion Control Plan, including a table of contents, shall be submitted for review and approval by the state authority.		
31	31. Erosion Control Plan, including a table of contents, shall be submitted for review and approval by the local authority.		
32	32. Erosion Control Plan, including a table of contents, shall be submitted for review and approval by the state authority.		
33	33. Erosion Control Plan, including a table of contents, shall be submitted for review and approval by the local authority.		
34	34. Erosion Control Plan, including a table of contents, shall be submitted for review and approval by the state authority.		
35	35. Erosion Control Plan, including a table of contents, shall be submitted for review and approval by the local authority.		
36	36. Erosion Control Plan, including a table of contents, shall be submitted for review and approval by the state authority.		
37	37. Erosion Control Plan, including a table of contents, shall be submitted for review and approval by the local authority.		
38	38. Erosion Control Plan, including a table of contents, shall be submitted for review and approval by the state authority.		
39	39. Erosion Control Plan, including a table of contents, shall be submitted for review and approval by the local authority.		
40	40. Erosion Control Plan, including a table of contents, shall be submitted for review and approval by the state authority.		
41	41. Erosion Control Plan, including a table of contents, shall be submitted for review and approval by the local authority.		
42	42. Erosion Control Plan, including a table of contents, shall be submitted for review and approval by the state authority.		
43	43. Erosion Control Plan, including a table of contents, shall be submitted for review and approval by the local authority.		
44	44. Erosion Control Plan, including a table of contents, shall be submitted for review and approval by the state authority.		
45	45. Erosion Control Plan, including a table of contents, shall be submitted for review and approval by the local authority.		
46	46. Erosion Control Plan, including a table of contents, shall be submitted for review and approval by the state authority.		
47	47. Erosion Control Plan, including a table of contents, shall be submitted for review and approval by the local authority.		
48	48. Erosion Control Plan, including a table of contents, shall be submitted for review and approval by the state authority.		
49	49. Erosion Control Plan, including a table of contents, shall be submitted for review and approval by the local authority.		
50	50. Erosion Control Plan, including a table of contents, shall be submitted for review and approval by the state authority.		

DES DAVIS ENGINEERS
24 DARWIN VILLAGE
WICKS FORT
DARWINVILLE, GA 30534
PHONE: 706.534.5134
DAVISENGINEERS.COM

FORC
FORC ENGINEERS
FORC ENGINEERS
FORC ENGINEERS

EROSION CONTROL NOTES & DETAILS
GAMESA PROPERTIES LLC - MARRETT STREET
14th CITY OF CANTON
CHEEREE COUNTY, GEORGIA

PROJECT NO. 15-21
SHEET NO. 21-219

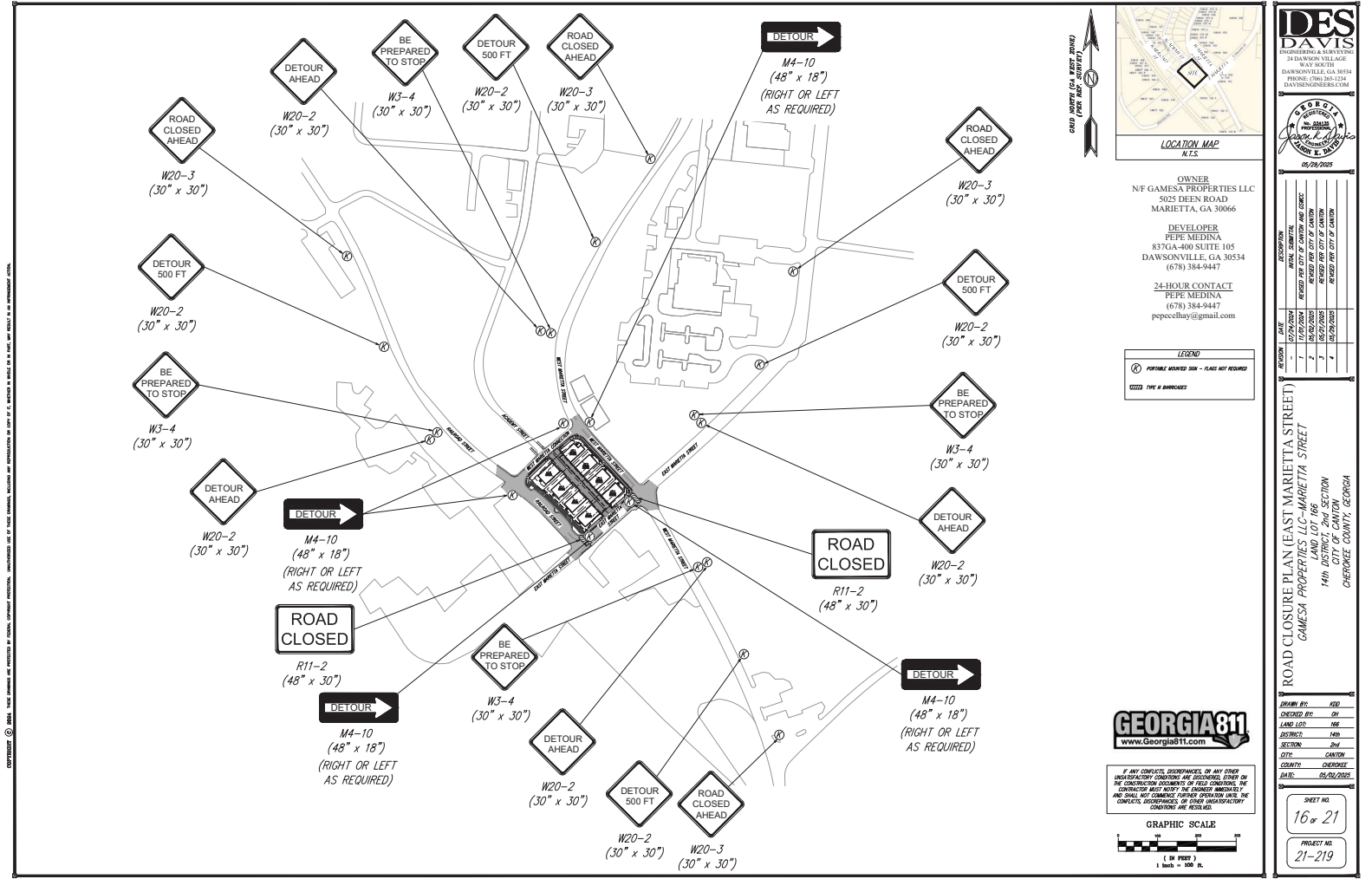

OLD MARIETTA (EAST STREET)
(FOR REF.)

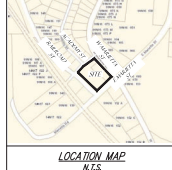

OWNER
NF GAMESA PROPERTIES LLC
5025 DEEN ROAD
MARIETTA, GA 30066

DEVELOPER
PEPE MEDINA
837GA-400 SUITE 105
DAWSONVILLE, GA 30534
(678) 384-9447

24-HOUR CONTACT
PEPE MEDINA
(678) 384-9447
pepecollay@gmail.com

LEGEND

Ⓢ PAVEMENT MARKED SIGN - FLAG NOT REQUIRED

Ⓢ TYPE II SIGNAGE



IF ANY CONFLICTS, DISCREPANCIES, OR ANY OTHER UNRESOLVABLE CONDITIONS ARE ENCOUNTERED, EITHER ON THE CONSTRUCTION DOCUMENTS OR FIELD CONDITIONS, THE CONTRACTOR MUST NOTIFY THE ENGINEER IMMEDIATELY BY AIR MAIL AND COMMENCE WORK STOPPAGE UNTIL THE CONFLICTS, DISCREPANCIES, OR OTHER UNRESOLVABLE CONDITIONS ARE RESOLVED.



DES DAVIS
ENGINEERS & ARCHITECTS
24 DAWSON VILLAGE
W. SCOTT
DAWSONVILLE, GA 30534
PHONE: (706) 564-1334
DAVISENGINEERS.COM



05/29/2025

REVISION	DATE	DESCRIPTION
1	07/24/2024	INITIAL SUBMITTAL
2	11/20/2024	REVISED PER CITY OF CANTON AND OWNER
3	05/29/2025	REVISED PER CITY OF CANTON
4	05/29/2025	REVISED PER CITY OF CANTON

ROAD CLOSURE PLAN (EAST MARIETTA STREET)
GAMESA PROPERTIES LLC - MARIETTA STREET
LAND LOT 106
SECTION 2
CANTON
14th CITY OF CANTON
CHEROKEE COUNTY, GEORGIA

DESIGN BY:	DD
CHECKED BY:	DD
LAND LDR:	BB
DESIGNED:	140
SECTION:	2nd
CITY:	CANTON
COUNTY:	CHEROKEE
DATE:	05/29/2025
SHEET NO.	16 of 21
PROJECT NO.	21-219

CONSULTING ENGINEER AND ARCHITECTS OF RECORD, CHEROKEE COUNTY, GEORGIA. VARIATIONS OF THIS PLAN FROM THE ORIGINAL PLAN SHALL BE AT THE RISK OF THE USER. THE USER SHALL BE RESPONSIBLE FOR OBTAINING ALL NECESSARY PERMITS AND APPROVALS FROM THE CITY OF CANTON AND THE CITY OF MARIETTA.

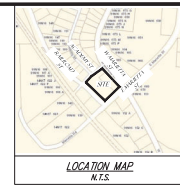
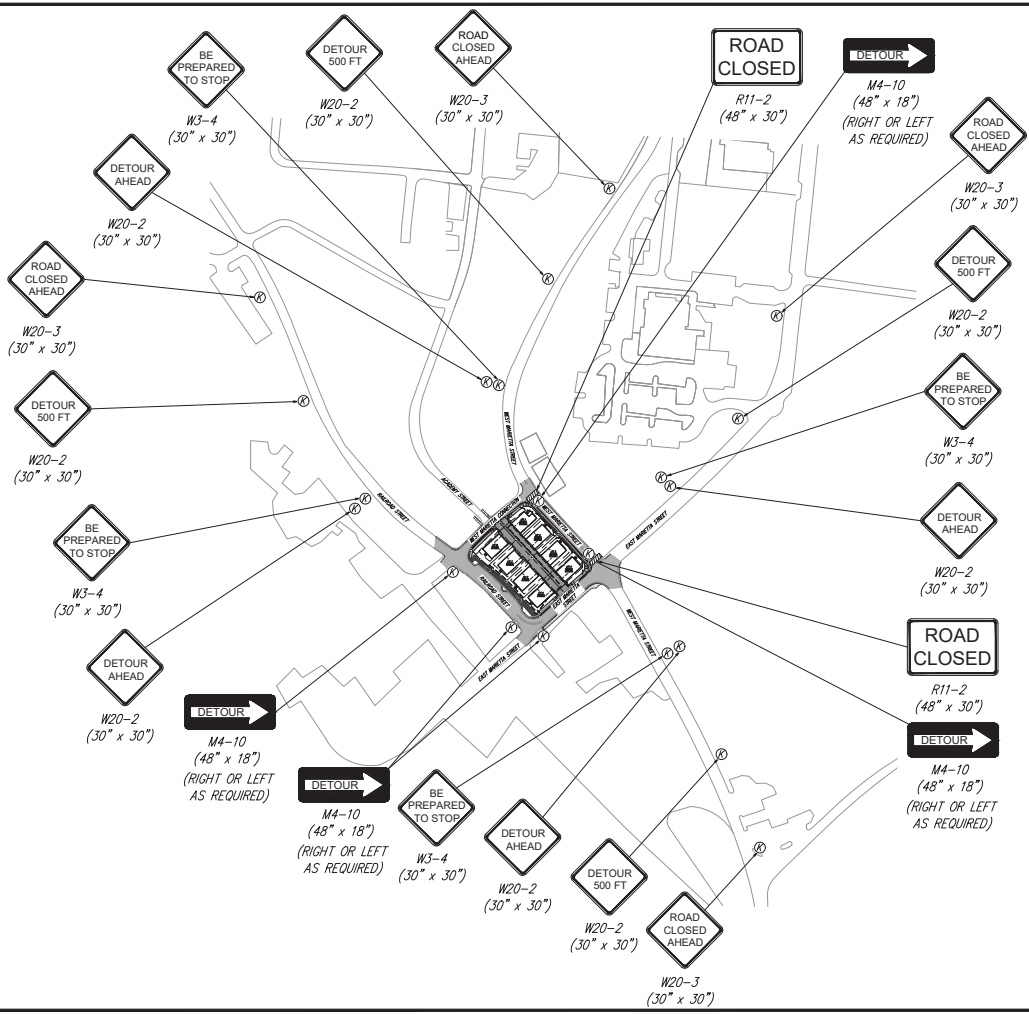

OWNER
 NF GAMESA PROPERTIES LLC
 5025 DEEN ROAD
 MARIETTA, GA 30066

DEVELOPER
 PEPE MEDINA
 8370A-400 SUITE 105
 DAWSONVILLE, GA 30534
 (678) 384-9447

24-HOUR CONTACT
 PEPE MEDINA
 (678) 384-9447
 pepecollay@gmail.com

LEGEND

① PERMISSIBLE WORKED SIGN - FLAG NOT REQUIRED

② PERMISSIBLE WORKED SIGN - FLAG NOT REQUIRED



IF ANY CONFLICTS, DISCREPANCIES, OR ANY OTHER UNUSUAL CONDITIONS ARE ENCOUNTERED, EITHER ON THE CONSTRUCTION DOCUMENTS OR FIELD CONDITIONS, THE CONTRACTOR MUST NOTIFY THE ENGINEER IMMEDIATELY BY AIR MAIL AND COMMENCE WORK STOPPING UNTIL THE CONFLICTS, DISCREPANCIES, OR OTHER UNUSUAL CONDITIONS ARE RESOLVED.

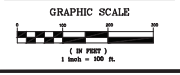

DES DAVIS
 ENGINEERS & ARCHITECTS
 24 DAWSON VILLAGE
 W. SCOTT
 DAWSONVILLE, GA 30534
 PHONE: (706) 584-1334
 DAVISENGINEERS.COM



05/29/2025

REVISION	DATE	DESCRIPTION
1	07/27/2024	INITIAL SUBMITTAL
2	11/27/2024	REVISED PER CITY OF CANTON AND OWNER
3	05/29/2025	REVISED PER CITY OF CANTON
4	05/29/2025	REVISED PER CITY OF CANTON

ROAD CLOSURE PLAN (WEST MARIETTA STREET)
 GAMESA PROPERTIES LLC - MARIETTA STREET
 LAND LOT 106
 14th CITY OF CANTON
 CHEROKEE COUNTY, GEORGIA

DESIGNER:	DD
CHECKED BY:	DD
LAND LDR:	BB
ESTIMATOR:	DD
SECTION:	2nd
CITY:	CANTON
COUNTY:	CHEROKEE
DATE:	05/29/2025
SHEET NO:	17 of 21
PROJECT NO:	21-219

COPYRIGHT © 2025. THIS DRAWING IS THE PROPERTY OF DES DAVIS ENGINEERS & ARCHITECTS. NO PART OF THIS DRAWING, INCLUDING THE CONTENTS THEREOF, SHALL BE REPRODUCED OR TRANSMITTED IN ANY FORM OR BY ANY MEANS, ELECTRONIC OR MECHANICAL, WITHOUT THE WRITTEN PERMISSION OF DES DAVIS ENGINEERS & ARCHITECTS.

CONTRACTOR'S NOTE: THESE DRAWINGS ARE SUBJECT TO LOCAL, STATE AND FEDERAL REGULATIONS. THE CONTRACTOR SHALL BE RESPONSIBLE FOR OBTAINING ALL NECESSARY PERMITS AND APPROVALS. THE CONTRACTOR SHALL BE RESPONSIBLE FOR OBTAINING ALL NECESSARY PERMITS AND APPROVALS. THE CONTRACTOR SHALL BE RESPONSIBLE FOR OBTAINING ALL NECESSARY PERMITS AND APPROVALS.

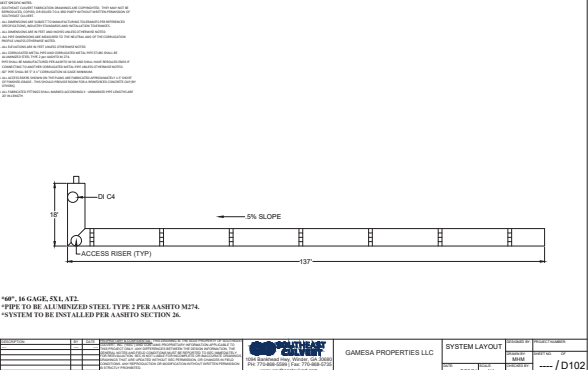
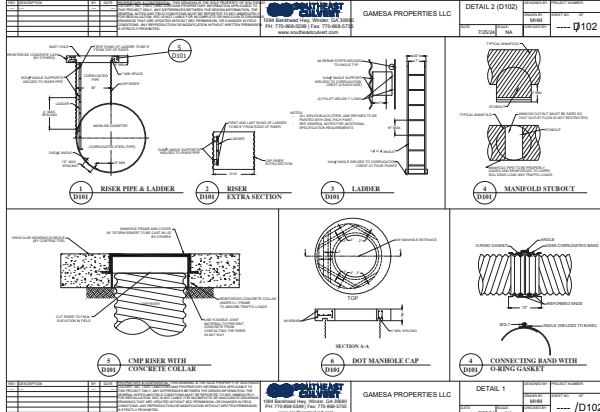
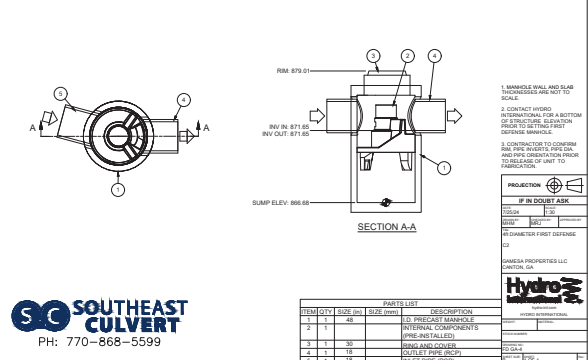
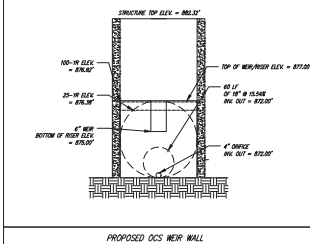
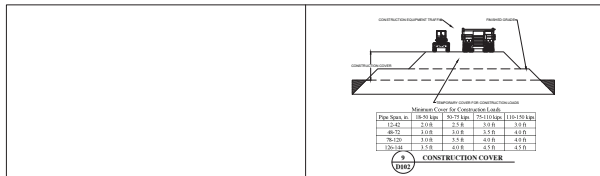

DES DAVIS
ENGINEERS & ARCHITECTS
24 DAWSON VILLAGE
W. 3000 S.W.
DUNWOODY, GA 30346
PHONE: 770.556.5334
DAVISENGINEERS.COM

PROJECT
STORMWATER MANAGEMENT DETAILS
GAMESA PROPERTIES LLC - MARETHA STREET
LAND LOT 196
14th CITY OF CANTON
CHEROKEE COUNTY, GEORGIA

DATE
05/29/2025

REVISION

NO.	DATE	DESCRIPTION
1	05/29/2025	INITIAL DESIGN
2	05/29/2025	REVISED PER CITY OF CANTON AND CHRO
3	05/29/2025	REVISED PER CITY OF CANTON
4	05/29/2025	REVISED PER CITY OF CANTON

SCALE
AS SHOWN

PROJECT NO.
21-219

SHEET NO.
18 of 21

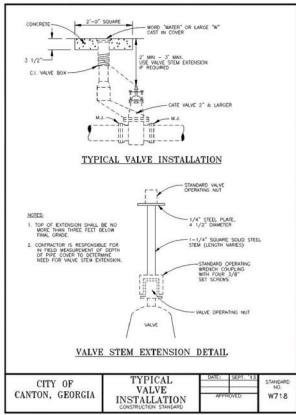

CITY OF CANTON, GEORGIA	TYPICAL VALVE INSTALLATION	DATE: 05/29/2025	DESIGNED BY: W718
-------------------------	----------------------------	------------------	-------------------

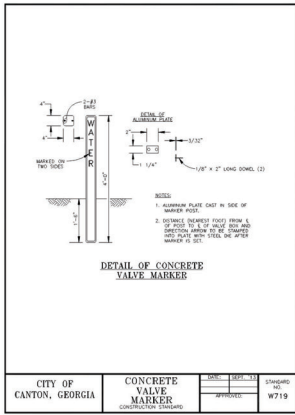

CITY OF CANTON, GEORGIA	CONCRETE VALVE MARKER	DATE: 05/29/2025	DESIGNED BY: W719
-------------------------	-----------------------	------------------	-------------------

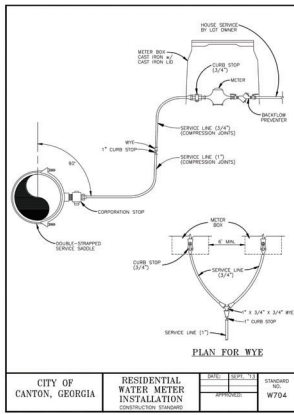

CITY OF CANTON, GEORGIA	RESIDENTIAL WATER METER INSTALLATION	DATE: 05/29/2025	DESIGNED BY: W704
-------------------------	--------------------------------------	------------------	-------------------

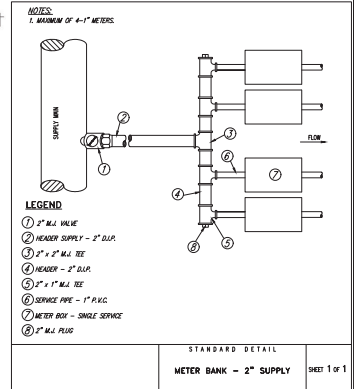

CITY OF CANTON, GEORGIA	METER BANK - 2" SUPPLY	DATE: 05/29/2025	DESIGNED BY: W717
-------------------------	------------------------	------------------	-------------------

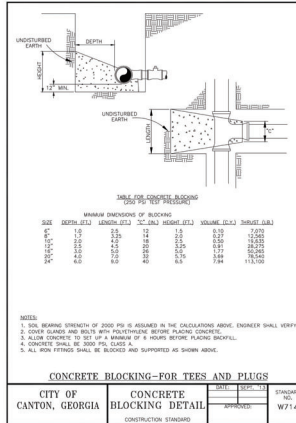

CITY OF CANTON, GEORGIA	CONCRETE BLOCKING DETAIL	DATE: 05/29/2025	DESIGNED BY: W714
-------------------------	--------------------------	------------------	-------------------

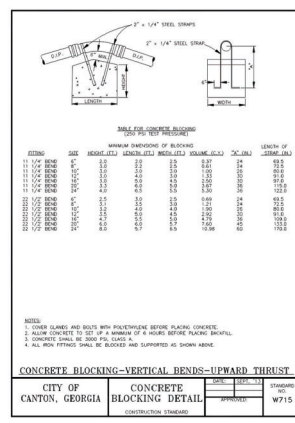

CITY OF CANTON, GEORGIA	CONCRETE BLOCKING DETAIL	DATE: 05/29/2025	DESIGNED BY: W715
-------------------------	--------------------------	------------------	-------------------

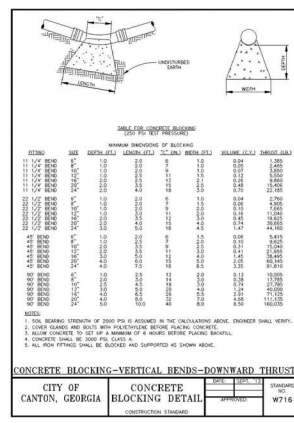

CITY OF CANTON, GEORGIA	CONCRETE BLOCKING DETAIL	DATE: 05/29/2025	DESIGNED BY: W716
-------------------------	--------------------------	------------------	-------------------

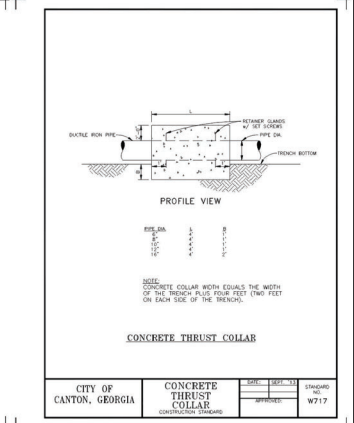

CITY OF CANTON, GEORGIA	CONCRETE THRUST COLLAR	DATE: 05/29/2025	DESIGNED BY: W717
-------------------------	------------------------	------------------	-------------------

DES DAVIS
 ENGINEERS & ARCHITECTS
 24 DAWSON VILLAGE
 WALKER HILL
 DAWSONVILLE, GA 30534
 PHONE: 706.526.5334
 DAVISENGINEERS.COM

FORC
 REGISTERED PROFESSIONAL ENGINEER
 STATE OF GEORGIA
 LICENSE NO. 10000-K-000000

05/29/2025

REVISION	DATE	DESCRIPTION
1	05/29/2025	INITIAL SUBMITTAL
2	05/29/2025	REVISED FOR CITY OF CANTON AND CHECK
3	05/29/2025	REVISED FOR CITY OF CANTON
4	05/29/2025	REVISED FOR CITY OF CANTON

CONSTRUCTION DETAILS
 GAMESA PROPERTIES LLC - MARETHA STREET
 LAND LOT 196
 SECTION 24
 TOWNSHIP 14N
 RANGE 14E
 COUNTY OF CANTON
 CHEROKEE COUNTY, GEORGIA

DESIGNED BY: W717
 CHECKED BY: CH
 LAND LDR: HEG
 DISTRICT: 140
 SECTION: 24
 TOWNSHIP: 14N
 RANGE: 14E
 COUNTY: CANTON
 STATE: GEORGIA

SHEET NO.
19 of 21

PROJECT NO.
21-219

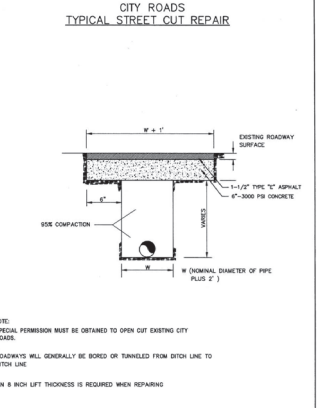
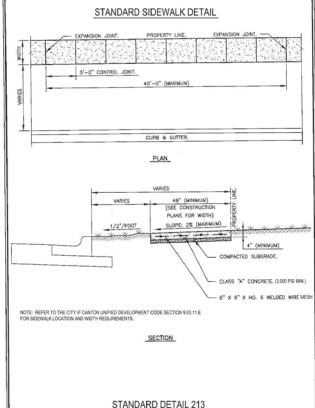
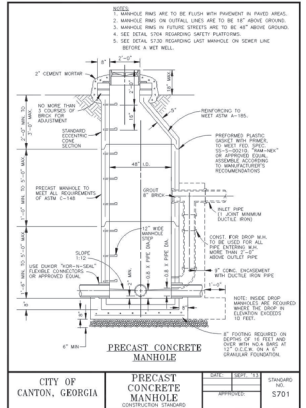
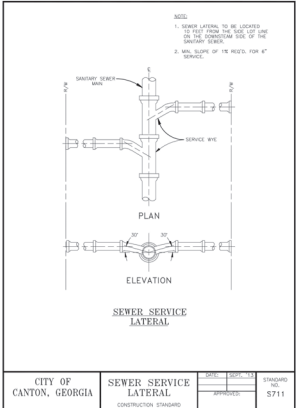
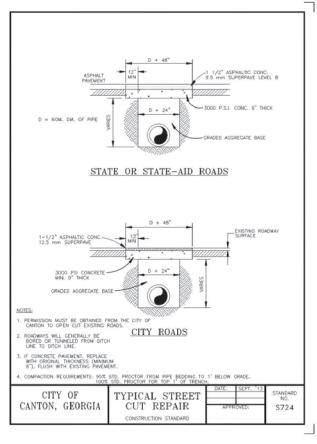
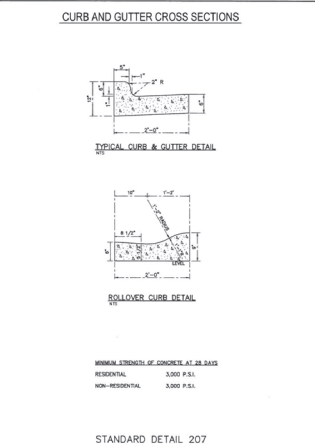
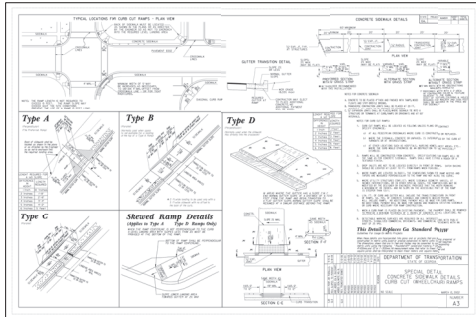
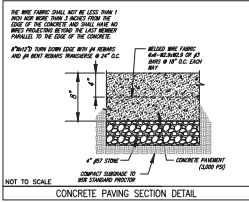
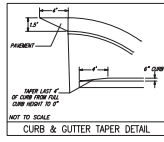
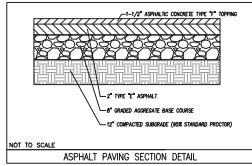

CITY OF CANTON, GEORGIA	SEWER SERVICE LATERAL	DATE: 05/29/2025	SCALE: 1/2\"/>
	CONSTRUCTION STANDARD	DESIGNER: JLS	ISSUED: 5/711

CITY OF CANTON, GEORGIA	PRECAST CONCRETE MANHOLE	DATE: 05/29/2025	SCALE: 1/2\"/>
	CONSTRUCTION STANDARD	DESIGNER: JLS	ISSUED: 5/701

CITY OF CANTON, GEORGIA	TYPICAL STREET CUT REPAIR	DATE: 05/29/2025	SCALE: 1/2\"/>
	CONSTRUCTION STANDARD	DESIGNER: JLS	ISSUED: 5/724

DES DAVIS
ENGINEERS & ARCHITECTS
24 DAWSON VILLAGE
WILKESBORO, NC 28696
PHONE: 703.526.5134
DAVISENGINEERS.COM



REVISION	DATE	DESCRIPTION
1	05/29/2025	INITIAL SUBMITTAL
2	05/29/2025	REVISED FOR CITY OF CANTON AND CHECK
3	05/29/2025	REVISED FOR CITY OF CANTON
4	05/29/2025	REVISED FOR CITY OF CANTON

CONSTRUCTION DETAILS
GAMESA PROPERTIES LLC - MARETHA STREET
LAND LOT 196
14th STREET
CITY OF CANTON
CHEROKEE COUNTY, GEORGIA

DATE: 05/29/2025	SCALE: 1/2\"/>
DESIGNER: JLS	CHECKED BY: CH
LAND LOTS: 196	SECTION: 2nd
CITY: CANTON	COUNTY: CHEROKEE
DATE: 05/29/2025	SCALE: 1/2\"/>

SHEET NO.
20 of 21
PROJECT NO.
21-219

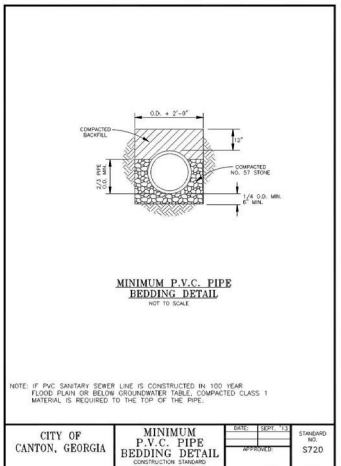
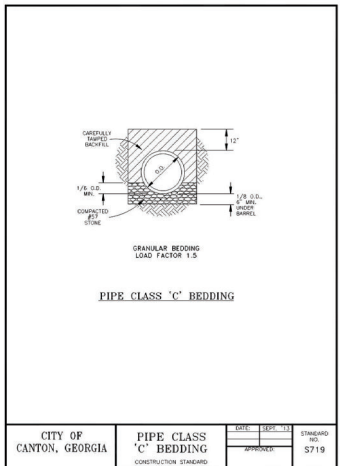
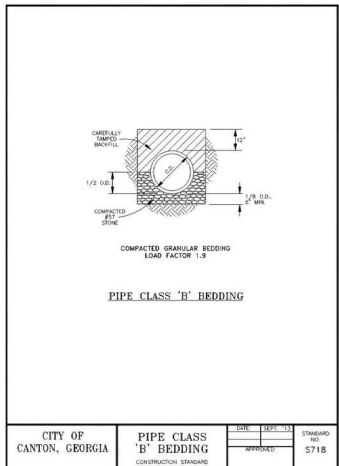
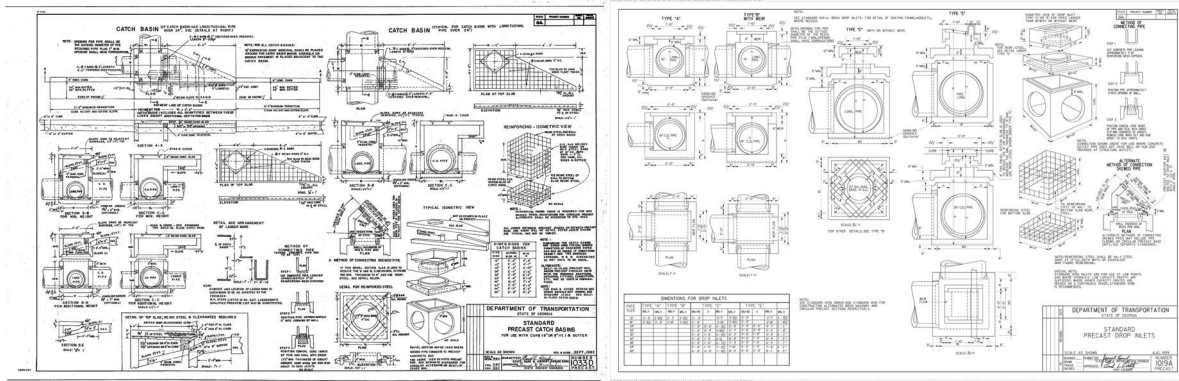

DES DAVIS
ENGINEERS & ARCHITECTS
24 DAWSON VILLAGE
WALKER BLVD
DUNWOODY, GA 30338
PHONE: 770.263.5334
DAVISENGINEERS.COM



REVISION	DATE	DESCRIPTION
1	12/24/2020	INITIAL SUBMITTAL
2	1/15/2021	REVISED FOR CITY OF CANTON AND CHECK
3	1/22/2021	REVISED FOR CITY OF CANTON
4	1/22/2021	REVISED FOR CITY OF CANTON

CONSTRUCTION DETAILS
 GAMESA PROPERTIES LLC - MARIETTA STREET
 LAND LOT 196
 SECTION 24
 CITY OF CANTON
 CHEROKEE COUNTY, GEORGIA

DESIGNED BY:	202
CHECKED BY:	DR
LAND LDR:	REG
DISTRICT:	140
SECTION:	24
CITY:	CANTON
COUNTY:	CHEOKEE
DATE:	05/20/2020
SHEET NO.	21 of 21
PROJECT NO.	21-219

CONTRACTOR'S NOTE: THESE DRAWINGS ARE PREPARED BY DES DAVIS, ENGINEERS & ARCHITECTS, INC. IN ACCORDANCE WITH THE GEORGIA PROFESSIONAL ENGINEERING ACT AND THE GEORGIA PROFESSIONAL ARCHITECTURE ACT. THE USER OF THESE DRAWINGS SHALL BE RESPONSIBLE FOR OBTAINING ALL NECESSARY PERMITS AND FOR OBTAINING ALL NECESSARY INFORMATION FROM THE CITY OF CANTON AND CHEROKEE COUNTY.

SYMBOL	DESCRIPTION
	40 SFP STANDARD TUB FLOORING SHOULD BE COMBO AT ALL TIMES W/ NO SEPARATE DOORS
	30 GAL STAINLESS STEEL 5 BURNER COOK TOP
	30 GAL GAS BURNER AND OVEN COMBO
	30 ELEC COOK TOP
	DOUBLE OVEN
	UNDERMOUNT DOUBLE BOWL KITCHEN SINK FACILITY WITH SPRINKLER AND GARABGE DISPOSAL
	UNDERMOUNT SINGLE BOWL KITCHEN SINK FACILITY WITH SPRINKLER AND GARABGE DISPOSAL
	DISHWASHER BELOW COUNTERTOP
	REFRIGERATOR
	SHOWER WITH SHOWER HEAD AND CONTROLS
	UNDERMOUNT VANITY SINK W/ COUNTER WITH W/ HANDBOOK AND VANITY LIGHTS
	TOILET
	WASHER AND DRYER
	CERAMIC TILES FULL HEIGHT ON WALLS, FLOORS
	47 GAL WATER HEATER

DOOR SCHEDULE - UNIT 4				
Mark	Size			Comments
	Width	Height	Thickness	
D-38	3'-0"	7'-0"	1 1/2"	OUTDOOR INSULATED DOOR WITH 1/2" LITE PROVIDE THRESHOLD, SWEET AND WEATHERSTRIPPING
D-39	3'-0"	7'-0"	1 1/2"	OUTDOOR INSULATED DOOR WITH 1/2" LITE PROVIDE THRESHOLD, SWEET AND WEATHERSTRIPPING
D-40	3'-0"	7'-0"	1 1/2"	STANDARD INTERIOR WOOD DOOR
D-41	3'-0"	7'-0"	1 1/2"	STANDARD INTERIOR WOOD DOOR WITH 1/2" LITE PROVIDE THRESHOLD, SWEET AND WEATHERSTRIPPING
D-42	3'-0"	7'-0"	1 1/2"	STANDARD INTERIOR WOOD DOOR
D-43	3'-0"	7'-0"	1 1/2"	STANDARD INTERIOR WOOD DOOR
D-44	3'-0"	7'-0"	1 1/2"	STANDARD INTERIOR WOOD DOOR
D-45	3'-0"	7'-0"	1 1/2"	STANDARD INTERIOR WOOD DOOR
D-46	3'-0"	7'-0"	1 1/2"	STANDARD INTERIOR WOOD DOOR
D-47	3'-0"	7'-0"	1 1/2"	STANDARD INTERIOR WOOD DOOR
D-48	3'-0"	7'-0"	1 1/2"	STANDARD INTERIOR WOOD DOOR
D-49	3'-0"	7'-0"	1 1/2"	STANDARD INTERIOR WOOD DOOR
D-50	3'-0"	7'-0"	1 1/2"	STANDARD INTERIOR WOOD DOOR
D-51	3'-0"	7'-0"	1 1/2"	OUTDOOR INSULATED DOOR WITH 1/2" LITE PROVIDE THRESHOLD, SWEET AND WEATHERSTRIPPING
D-52	3'-0"	7'-0"	1 1/2"	STANDARD INTERIOR WOOD DOOR
D-53	3'-0"	7'-0"	1 1/2"	STANDARD INTERIOR WOOD DOOR
D-54	3'-0"	7'-0"	1 1/2"	STANDARD INTERIOR WOOD DOOR
D-55	3'-0"	7'-0"	1 1/2"	STANDARD INTERIOR WOOD DOOR
D-56	3'-0"	7'-0"	1 1/2"	STANDARD INTERIOR WOOD DOOR
D-57	3'-0"	7'-0"	1 1/2"	STANDARD INTERIOR WOOD DOOR
D-58	3'-0"	7'-0"	1 1/2"	STANDARD INTERIOR WOOD DOOR
D-59	3'-0"	7'-0"	1 1/2"	STANDARD INTERIOR WOOD DOOR
D-60	3'-0"	7'-0"	1 1/2"	STANDARD INTERIOR WOOD DOOR

RC 2018 TABLE WALL (ALL EXTERIOR WALLS)			
EXTERIOR WALL ELEMENT	MIN. FIRE RESISTANCE RATING	MIN. FIRE SEPARATION DISTANCE	
WALLS	FIRE RESISTANCE RATED	4 HOURS	0 FEET
	NOT FIRE RESISTANCE RATED	0 HOURS	>= 3 FEET
PROJECTIION	FIRE RESISTANCE RATED	4 HOURS	>= 3 FEET TO 4 FEET
	NOT FIRE RESISTANCE RATED	0 HOURS	>= 4 FEET
OPENING IN WALLS	NOT ALLOWED	N/A	> 3 FEET
	20% MAXIMUM OF WALL AREA	0 HOURS	3 FEET
	UNLIMITED	0 HOURS	0 FEET
PENETRATIONS	ALL	COMPLY W/ RC 4	3 FEET
		NOT REQUIRED	0 FEET

SL
NOVATION STUDIOS

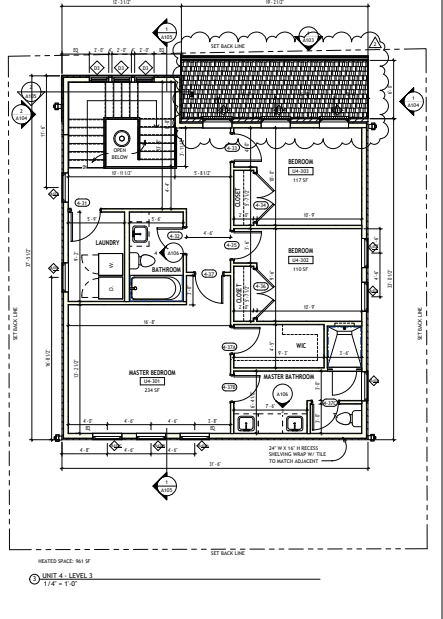
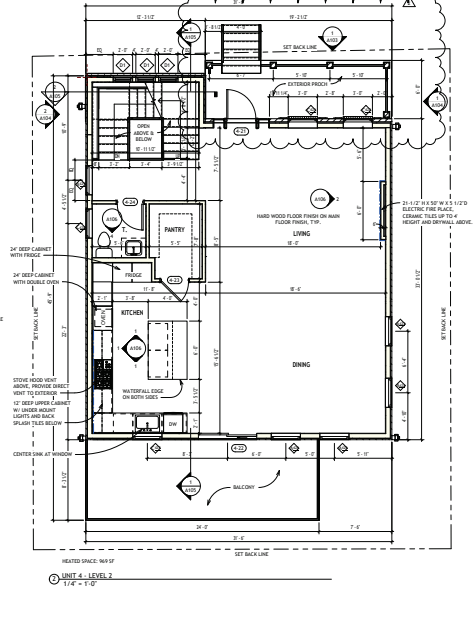
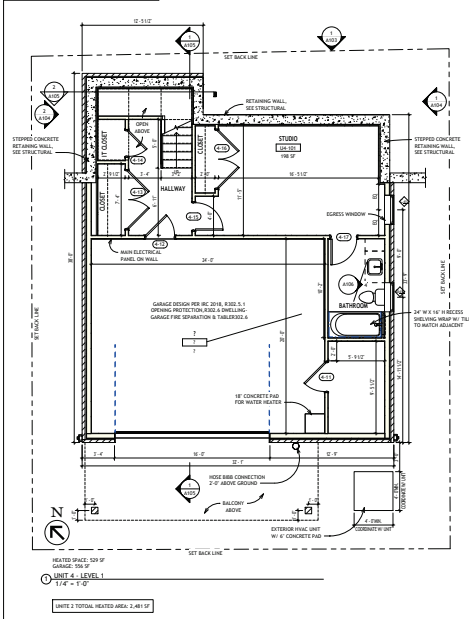

242 W MARIETTA ST,
CANTON, GA 30114

CLIENT: GAMESA PROPERTIES LLC
ADDRESS: 5025 Deen Rd., Marietta, GA 30066

NO.	DESCRIPTION	DATE
1	CONSTRUCTION DOCUMENTS	2025-10-20
2	RFPS COMMENTS	2026-03-16

UNIT 4 - FLOOR PLANS

A101

DESCRIPTION

Introducing an exclusive collection of eight thoughtfully designed residences nestled within the heart of Canton's Historic District. This boutique development gated blends timeless architectural character with modern comfort, honoring the rich heritage of the area while offering refined contemporary living, Designed with architectural cohesion and attention to detail.

The exterior showcases lap siding, smooth vertical panel siding, complemented by a brick with limewashed looking color tones water table or walls for added texture and durability.

The houses will be in the white palate with bold gray accents define the architectural character, including framed energy-efficient windows and a framed glass front door. A contemporary front porch with wood columns and shingle roof add both visual interest and functional weather protection.

A raised front porch covered provides durability and low maintenance while enhancing the clean, modern aesthetic.

301 W Marietta St, Canton, Ga. 30114

